

**HOW
TO
USE
YOUR**

YASHICA 635

THE YASHICA MODEL 635

is a versatile camera which can take 6×6 cm ($2\frac{1}{4}'' \times 2\frac{1}{4}''$) pictures (using 120 film) or 24×36 mm pictures (using 35 mm film). It has a built-in rewind device for the 35 mm film. It is also a multi-purpose camera which will meet the requirements of portrait work, ordinary snap shots, close-up photography, copy work and making color slides.

To fully exploit all the advantages of your Yashica
 To take better pictures with more confidence
 To maintain the flawless operation of the camera

LEATHER CARRYING CASE

The genuine leather carrying case is specially designed with compartments to carry the YASHICA 635 Camera, 35 mm Conversion Kit, extra rolls of 120 and 35 mm films and accessories



Read the following descriptions carefully until you become fully familiar with all these working parts.

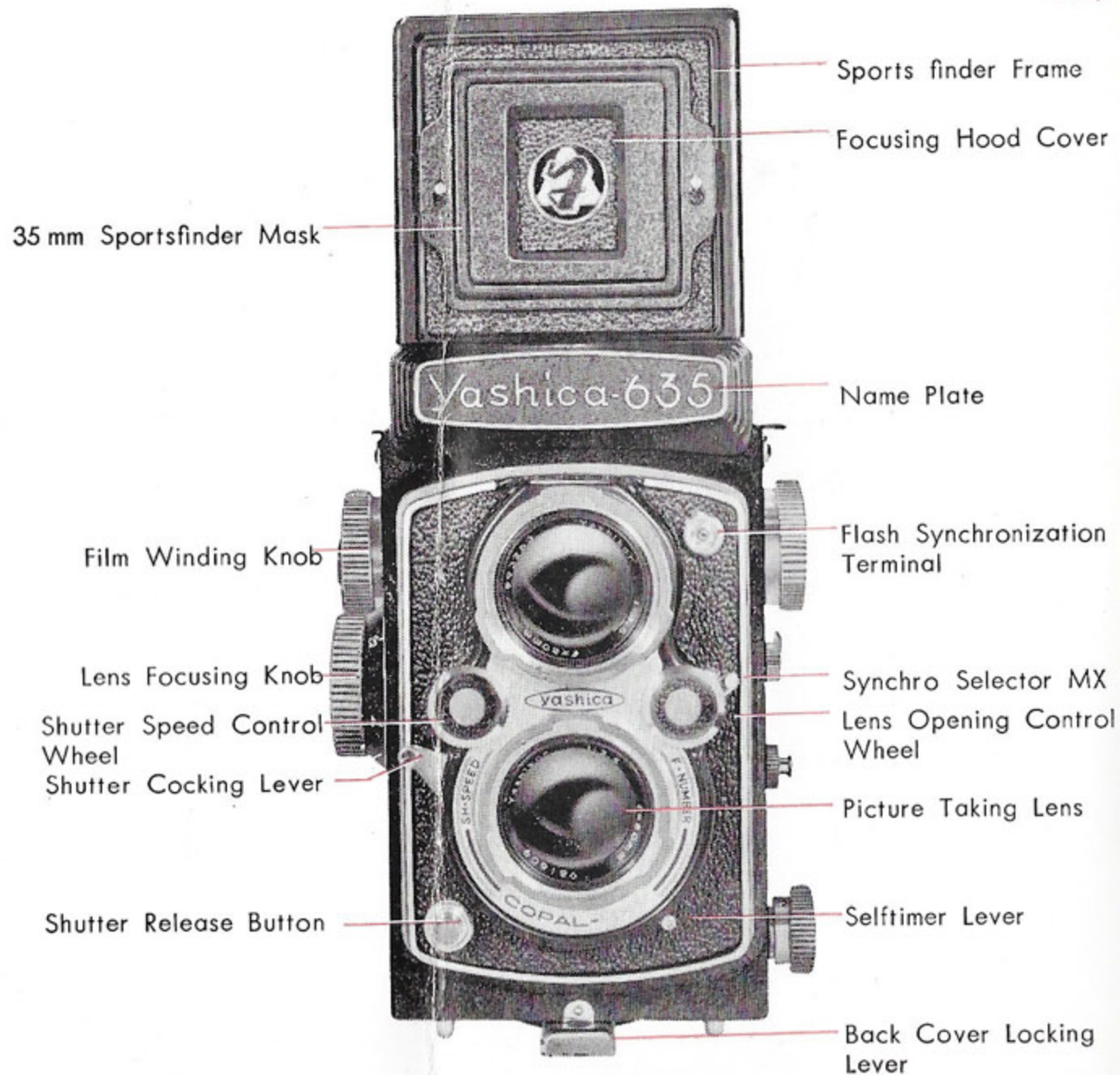

- | | | |
|--------------------------|-----------------------------|--------------------------------|
| (1) ASA Speed Dial | (6) 35 mm Film Winding Knob | (12) Back Cover |
| (2) Film Release Button | (7) Rewind Release Button | (13) Film Pressure Plate |
| (3) Strap Holder | (8) Accessory Shoe | (14) Reverse Arm |
| (4) Film Counter Window | (9) Film Release Button | (15) 35 mm Film Pressure Plate |
| (5) Depth-of-Field Scale | (10) Spool Locking Spring | (16) Metal Adapter Ring |
| | (11) Tripod Socket | (17) 35 mm Film Cartridge |

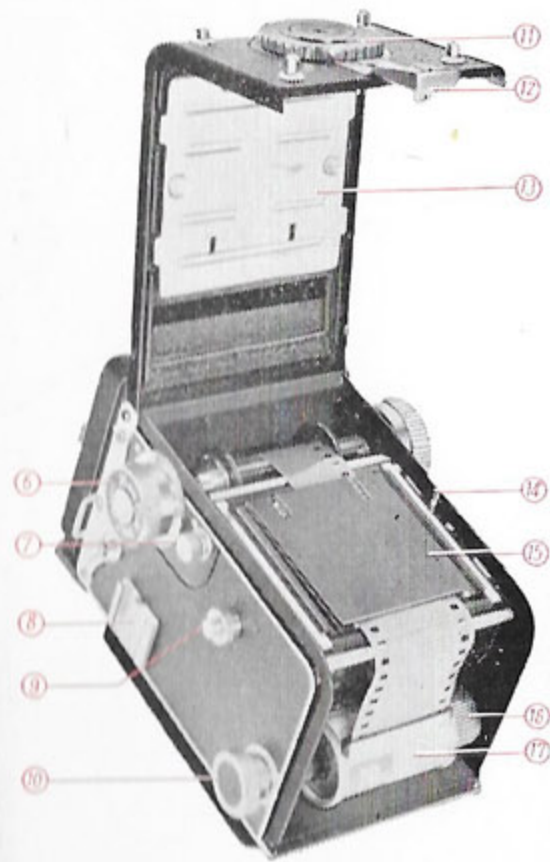
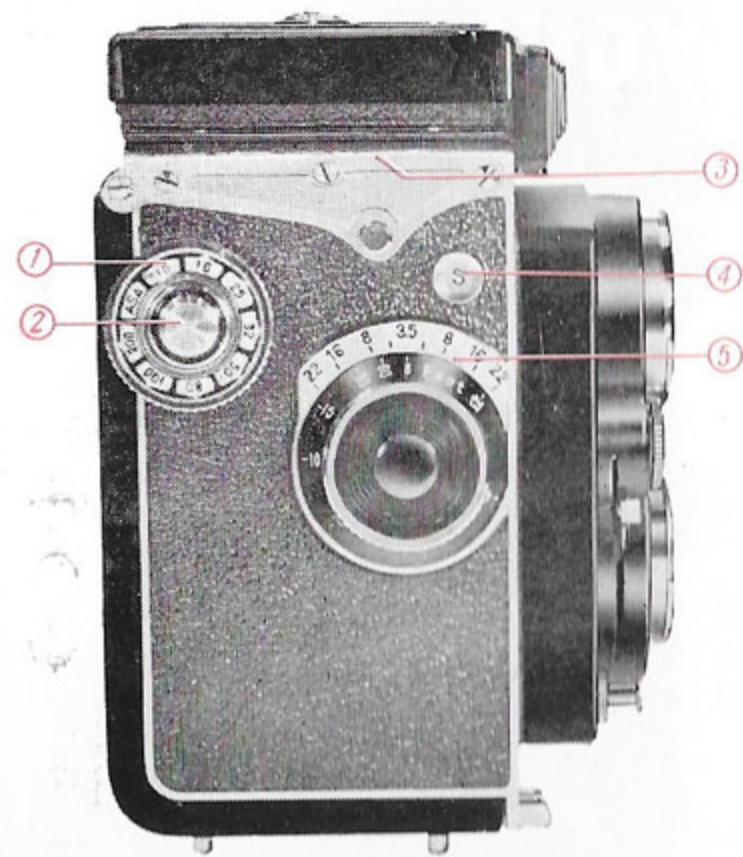

LOADING FILM

120 size film
12 pictures per roll
in the popular $2\frac{1}{2} \times 2\frac{1}{2}$ size
Black-and-White or Color

- (1) To unlock back cover, turn the tripod socket in the direction marked 'O'. Then open the Back Cover by swinging it out.
- (2) Remove the Take-Up Spool in the Lower Film Chamber by pulling out the Lower Film Spool Locking Spring.
- (3) Place the Take-Up spool in the Upper Film Chamber by pulling out the Upper Film Spool Locking Spring.
- (4) Place a new roll of size 120 film in the Lower Film Chamber.
- (5) Gently draw out the film leader. Thread the film leader into the wider slot of the Take-Up Spool in the Upper Film Chamber, then turn the Film Winding Knob. Make sure that the film leader is placed evenly.

- (6) Turn the Film Winding Knob until the arrow on the film itself is adjacent to the red triangle on the camera body. Replace the camera back and lock it in place.
- (7) To close the camera back cover, turn the tripod-socket in the direction marked "C".
- (8) When the back cover is closed and locked, the letter "S" appears in the Film Counter Window automatically.
- (9) Then just turn the knob until the number "1" appears in the window. You are ready for your first picture.
- (10) After taking a picture, push the Film Release Button and turn the Film Winding Knob so that the Film Counter Window shows the next number. The Film Winding Knob will lock automatically.

Caution: When loading or unloading film stand in a shadow—never in strong, direct sunlight.

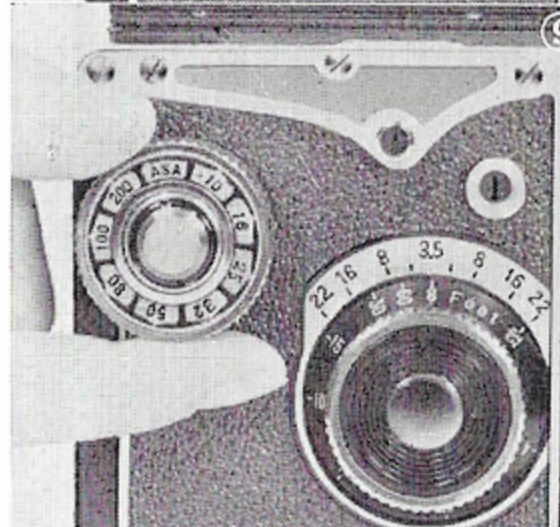
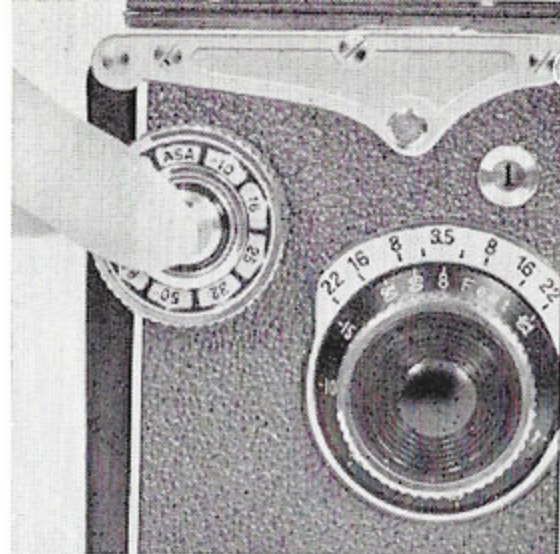
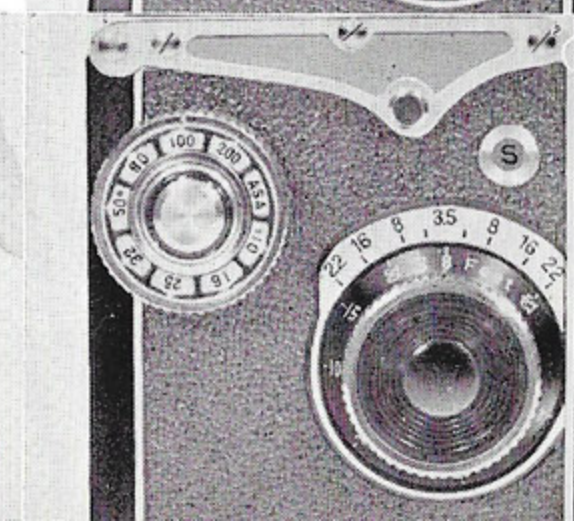
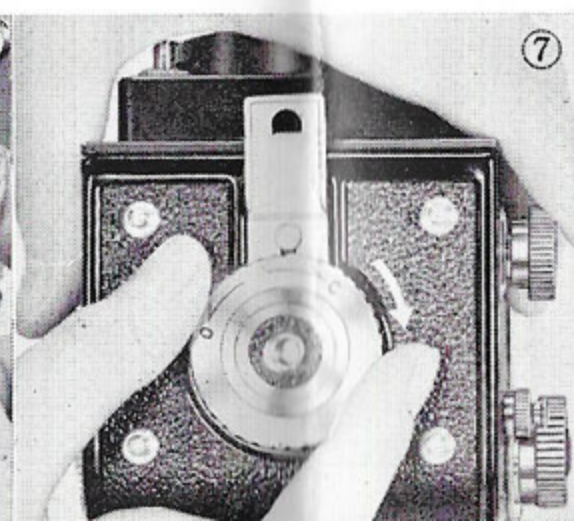
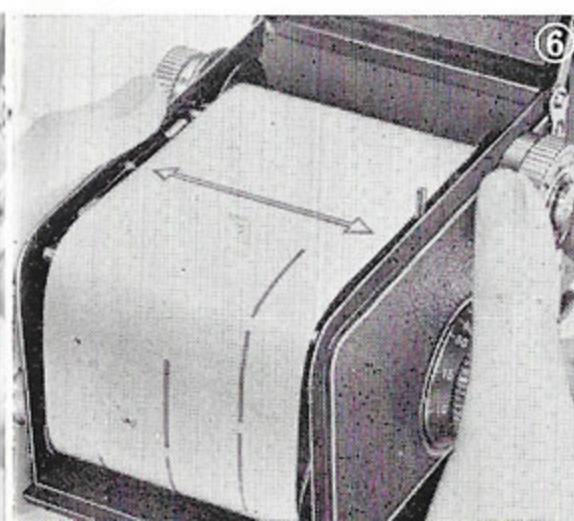
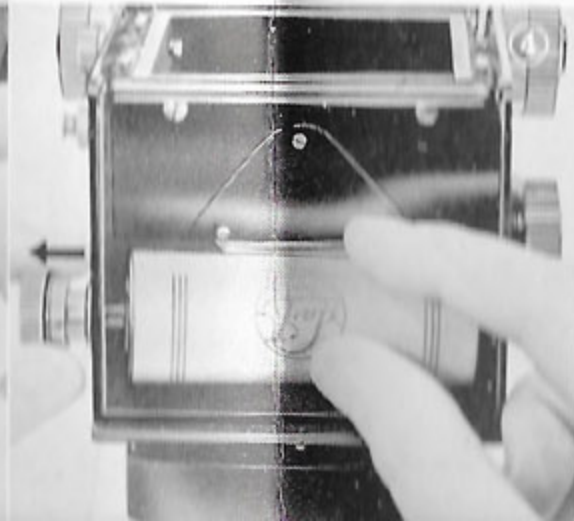
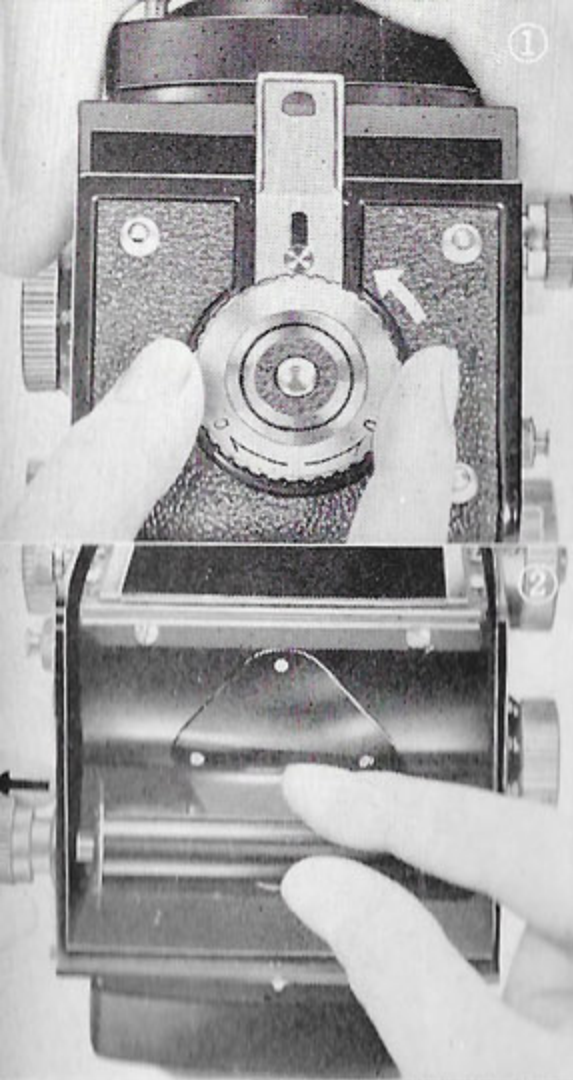

PICTURE TAKING PROCEDURE

(1) Open the Viewfinder Hood by lifting it at back. Press the Viewfinder Hood down to close it.

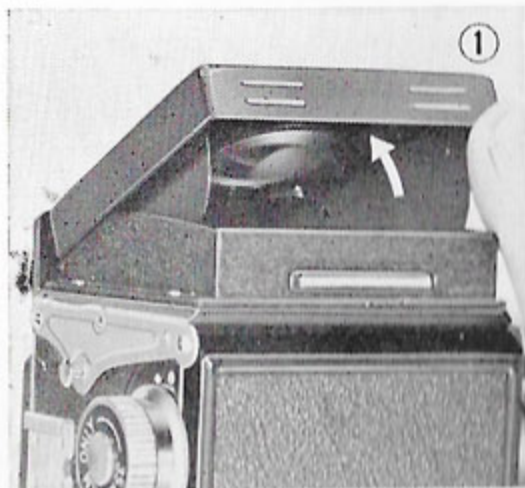

(2)~(3) The shutter speed (right) and lens opening (left) is set by turning the Control Wheels with your thumbs in either direction, up or down, as indicated by the arrows. The red shutter speed figures and the black lens opening figures should be set so that the red line in the window runs exactly through the center of the figures.

(4) Push down the Shutter Cocking Lever. Be sure not to change Shutter Speed after the Shutter is cocked. Now gently release the Shutter by pressing the Shutter Release Button. See arrow mark.

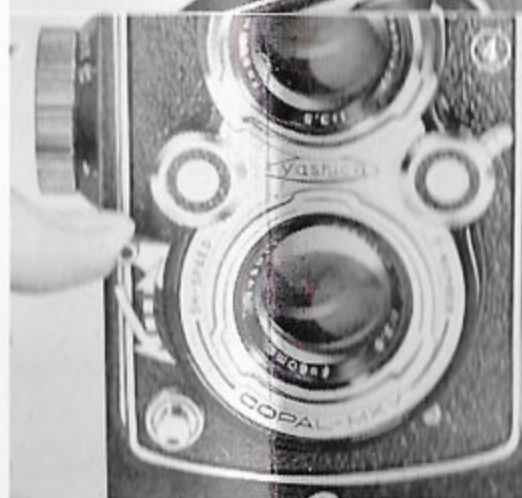
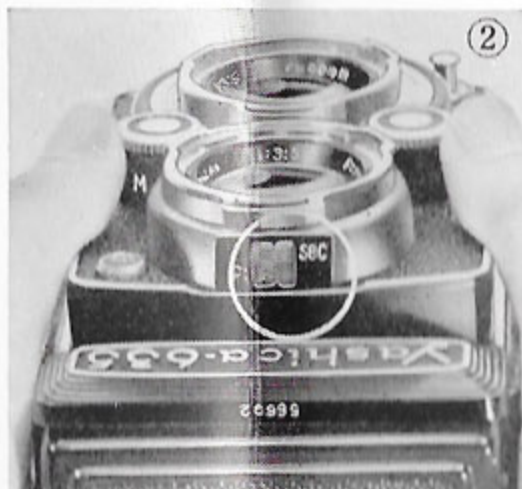

TO REMOVE THE LENS CAP

Raise the lower cap and fold back on its hinge. Turn the upper cap counter clockwise and remove.

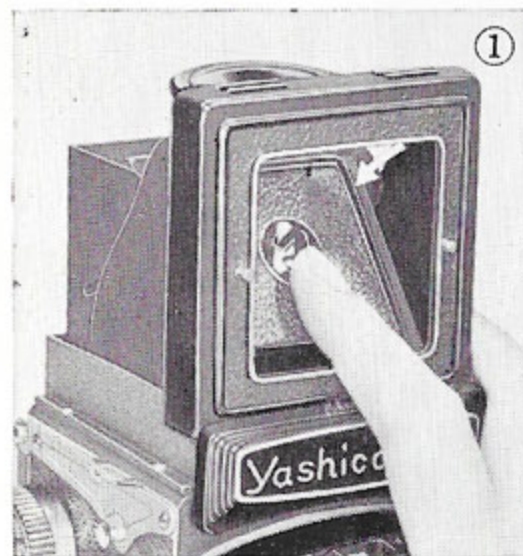
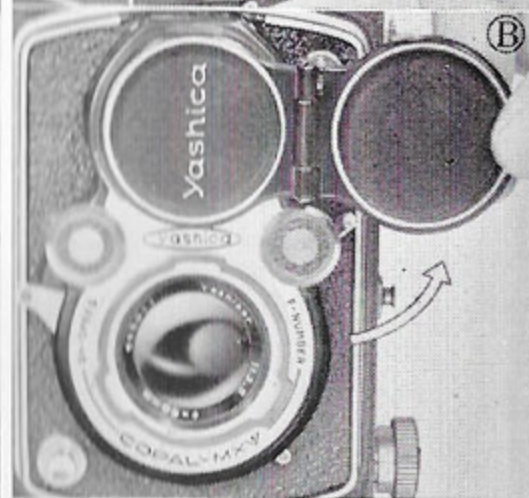
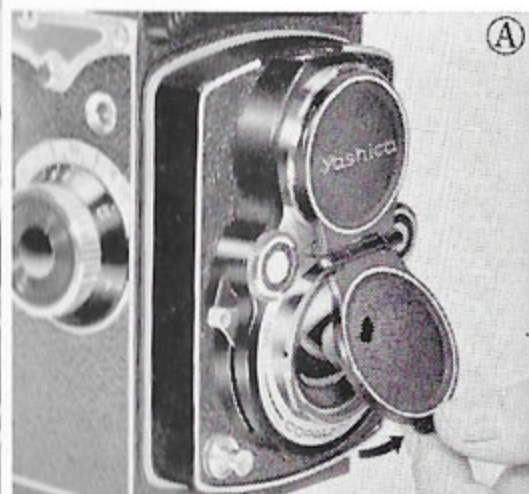

MAGNIFYING GLASS

Assures more accurate focusing.

(1) Raise the Magnifying Glass by pressing the front of the Focusing Hood Cover inward, holding the Focusing Hood so that it does not close. When using the Magnifying Glass, place your eye as close to the Magnifying Glass as possible.

(2) Always make sure that you have first lowered the Magnifying Glass before closing the Focusing Hood.



(A) Depress the Focusing Hood Cover until it clicks into place. Lift the Yashica to your eye level.

SPORTS FINDER

Sight your subject through the sportsfinder window.

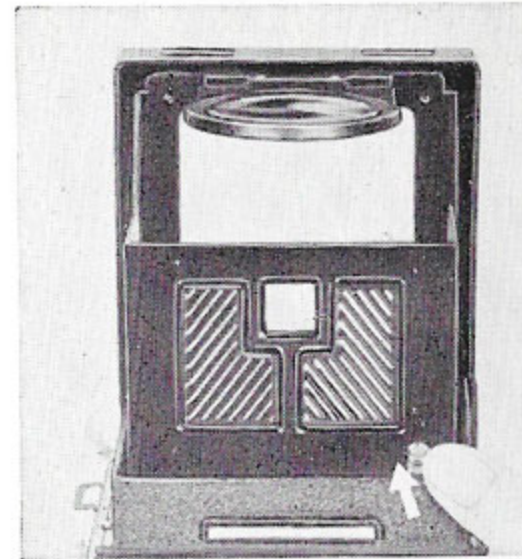

(B) Push the Release Button when closing it.

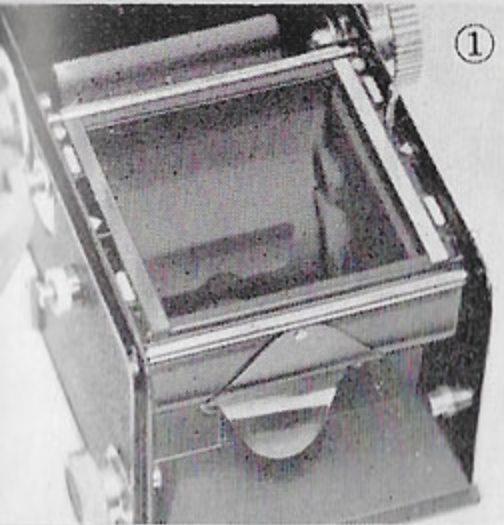

①

LOADING THE 35 MM. FILM

- (1) Pull out the Rewind Release Button (R) and give it a twist.
- (2) Install the 35 mm Converter Mask Assembly. Point the two sprockets of the assembly towards the Upper Film Chamber, and insert the assembly from the bottom with a little pressure on the Pressure Bar and it will set in easily. The springs in the Pressure Bar will firmly secure the 35 mm Converter Mask Assembly to the camera.
- (3) Replace Rewind Release Button to original position which will set the lock, and the sprockets are ready to turn.
- (4) Screw the metal Adapter Ring to the spool supporter shaft on the right inner side of the Lower Film Chamber.
- (5) Insert the Auxiliary Supporter Shaft into the spool of the Film Cartridge.

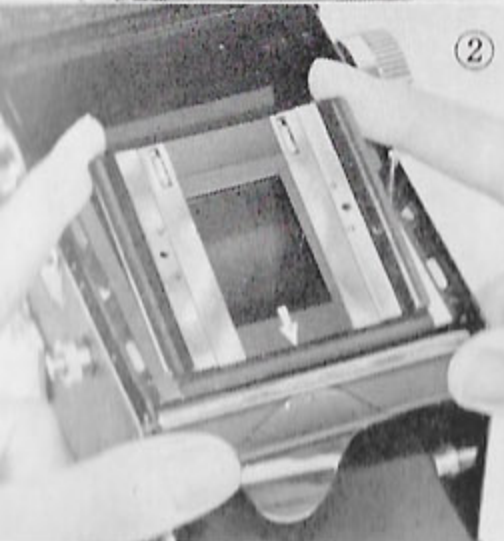

②



③

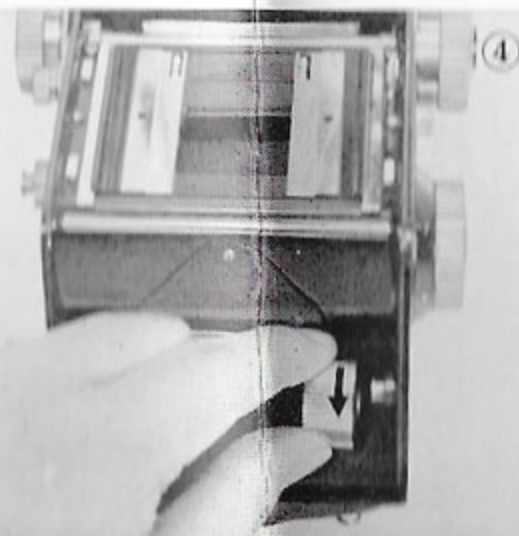

④

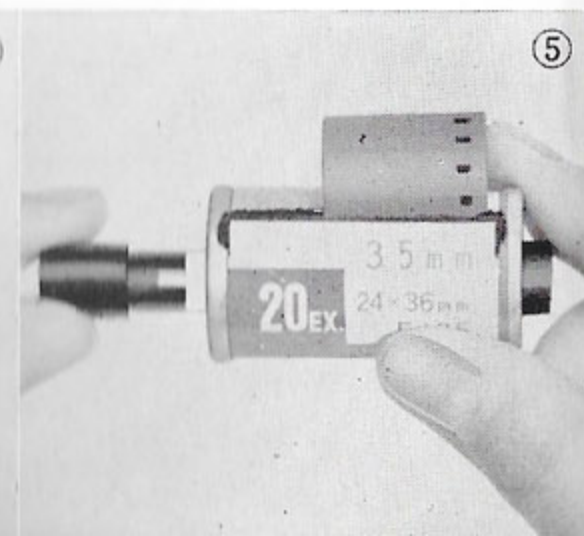

⑤

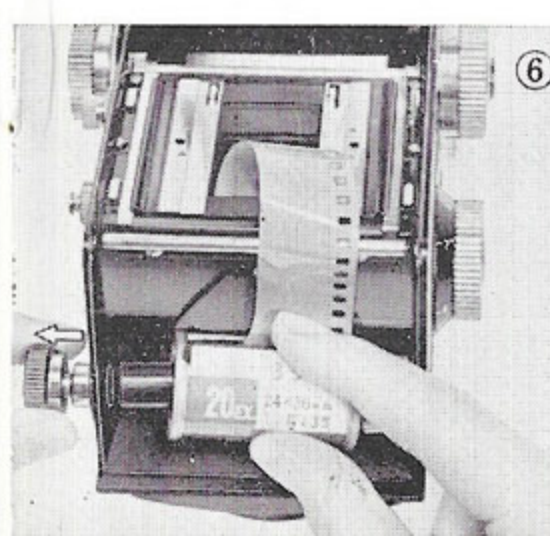

⑥

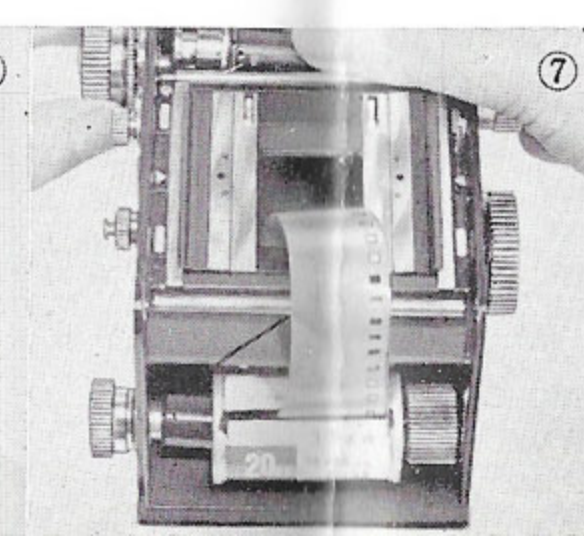

⑦

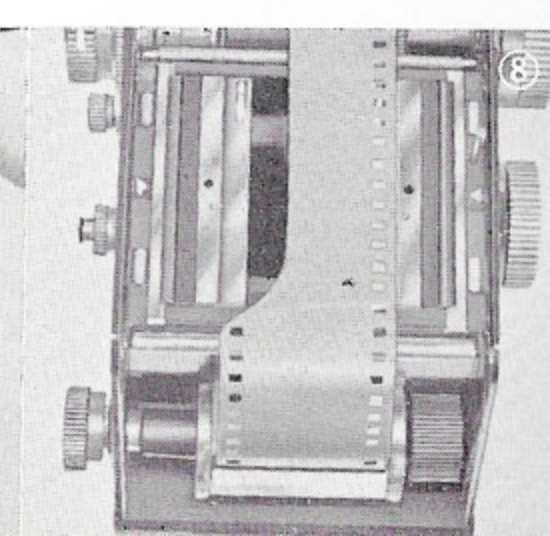

⑧

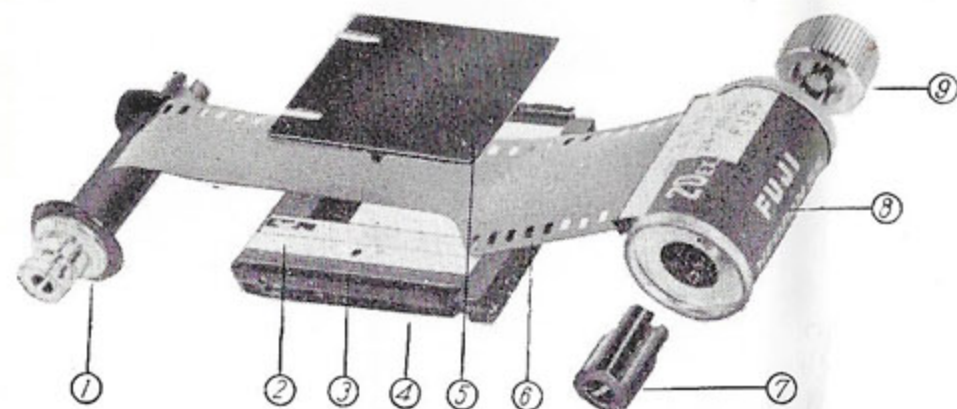

- (1) 35 mm Auxiliary Spool Assembly
- (2) Sprocket
- (3) Pressure Plate Aligning Hole
- (4) 35 mm Converter Mask Assembly
- (5) 35 mm Film Pressure Plate
- (6) 35 mm Film
- (7) Auxiliary Supporter Shaft
- (8) 35 mm Film Cassette
- (9) Metal Adapter Ring

- (6) Place the assembled Film Cartridge in the Lower Film Chamber by pulling out the film spool locking spring. Gently draw out the film.
- (7) Install the 35 mm Auxiliary Spool Assembly by aligning the grooves in the shaft to the supporter shaft on the right inner side of the Upper Film Chamber. Next, pull out the 35 mm Film Winding Knob and insert the metal end of the 35 mm Auxiliary Spool Assembly; release the Winding Knob and give it a few turns until the Auxiliary Spool begins to turn. If the 35 mm Film Winding Knob does not turn press the Film Release Button (below Re-wind Release Button "R"), and this will release the lock.
- (8) Thread the film into the slot of the Auxiliary Spool in the Upper Film Chamber, then turn the 35 mm Film Winding Knob. Make sure the perforations in the film are threaded to the sprockets.

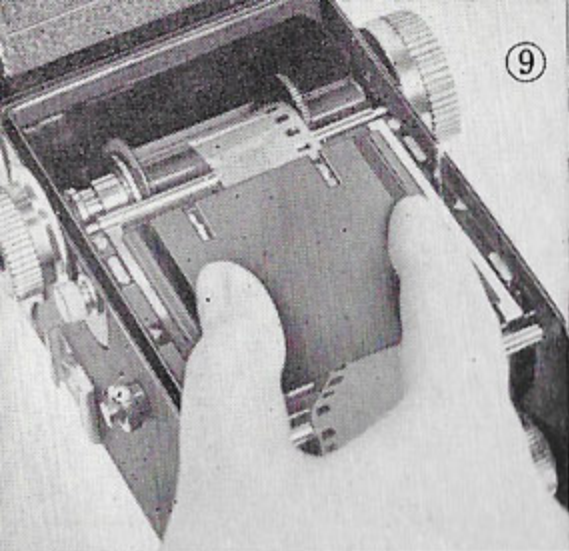

9

- (9) Place the Film Pressure Plate with the protrusions facing downwards between the film, and set in position by pressing the protrusions into the holes provided in the 35 mm Converter Mask Assembly.
- (10) Close the camera Back Cover. Press the Film Release Button once, and turn 35 mm Film Winding Knob until it locks. Repeat this operation three times.
- (11) Set the Exposure Indicator Dial to number one. The film is now ready to take the first exposure.

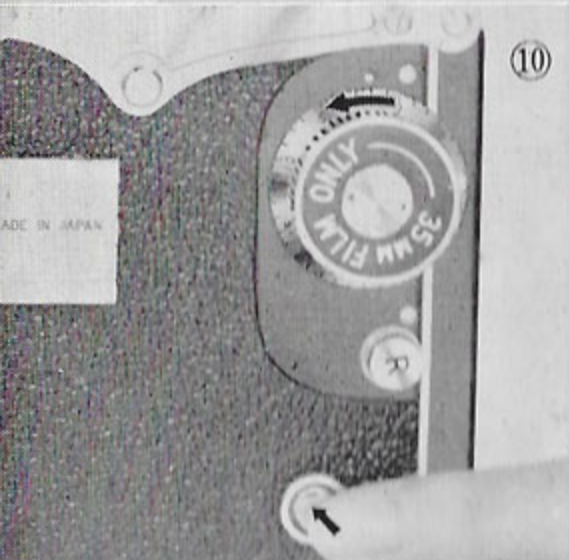

10

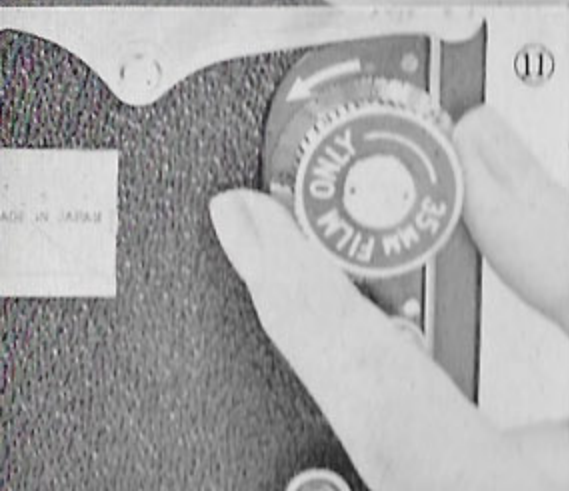

11

YASHIKOR F 3.5 LENS

The YASHICA 635 Camera is equipped with YASHIKOR 80 mm F 3.5 Lens. It is hard coated and color corrected, which is ideal for color photography.

When taking pictures with 35 mm film, this lens will prove to be excellent for portrait photography. At the same time, it will also serve as a Telephoto Lens giving a larger image and narrower field of view than the standard lens fitted to 35 mm cameras.

TO REWIND THE 35 MM. FILM

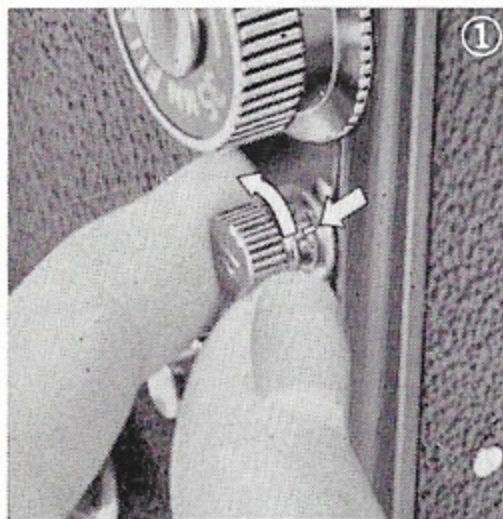

1

(1) After the film has been exposed it will be necessary to rewind the film back to its cartridge. Pull out the Rewind Release Button (R) and give it a slight turn.

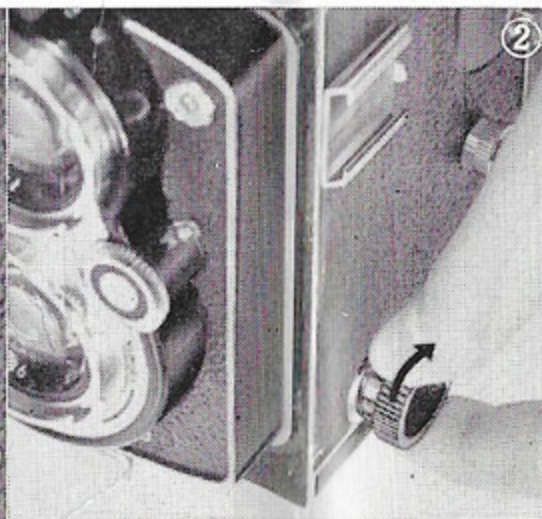

2

(2) Turn the Film Spool Locking Knob in the direction of the arrow until the film is completely in the cartridge.

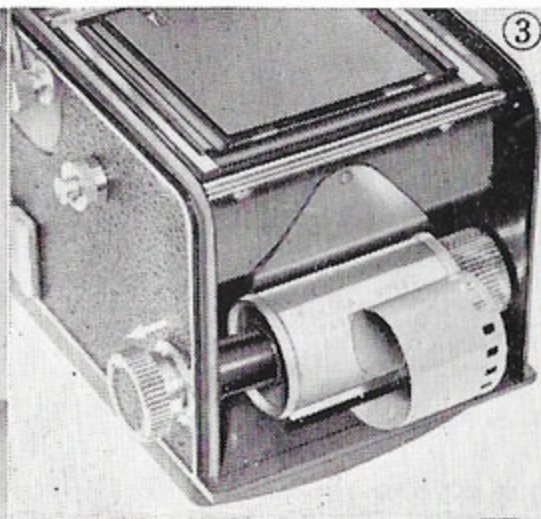

3

(3) Open the Back Cover. Remove the cartridge by pulling out the Film Spool Locking Spring Knob.

TAKING PICTURES WITH 35 MM. FILM

(A) Always remember to sight and compose your picture within the Red Lines marked on the ground glass viewing screen.

(B) When using the Sportsfinder it will be necessary to attach the 35mm Sportsfinder Mask to Viewfinder by means of the two pins provided for it on the Viewfinder.

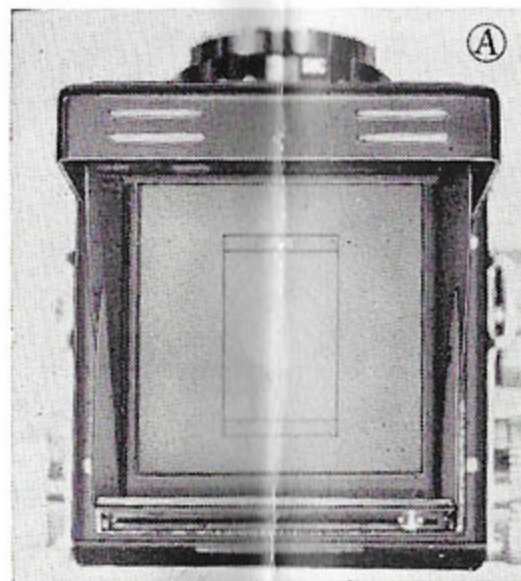

A

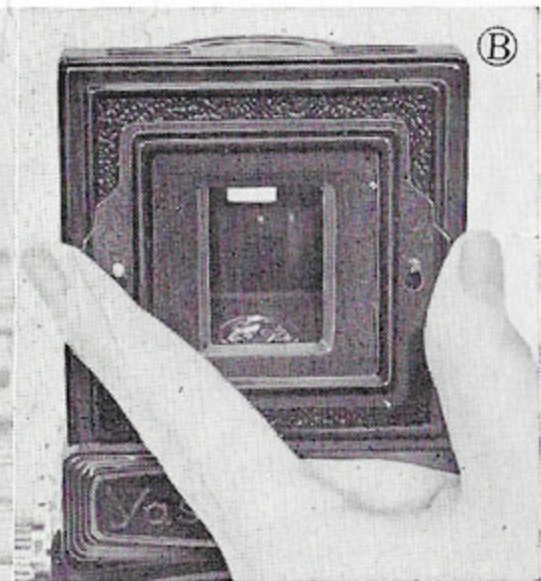

B

TAKING FLASH PICTURES

Your Yashica offers M-X synchronization

Selector Position	M	X	X
Bulb used	Medium Peak	Short Peak	Medium Peak
Shutter Speed	Any Speed	1/50 or slower	1/25 or slower (When using self-timer)

Do not use Short Peak Bulb with "M" Synchronization. Move the selector to X position when using Electronic Flash.

Your camera dealer will be glad to supply the proper flash attachment for your camera.

As you become more proficient at taking pictures, you will want to acquire accessories that increase the versatility of your Yashica. One of the first accessories you will want will be a flash unit. Your Yashica is ready and waiting. Synchronization for flash is built-in. A standard PC connector plugs into the flash terminal.

The battery case slips into the Accessory shoe or attaches to the camera via an arm that screws into the tripod socket.

CABLE RELEASE

A standard, overlap-type Cable Release can be fitted to your Yashica. Simply unscrew the Shutter Release Ring and screw in the Cable Release. Your camera dealer will supply the proper Cable Release for your camera. See above picture.

SELF-TIMER

The Self-timer, for taking self-portraits or group pictures, gives you about 8 seconds to get into the picture.

(A) **Caution!** Be sure to move the synchronization selector to the X position when using Self-timer. (B) Then set the speed, cock the shutter and move the Self-timer in the direction shown by the arrow.

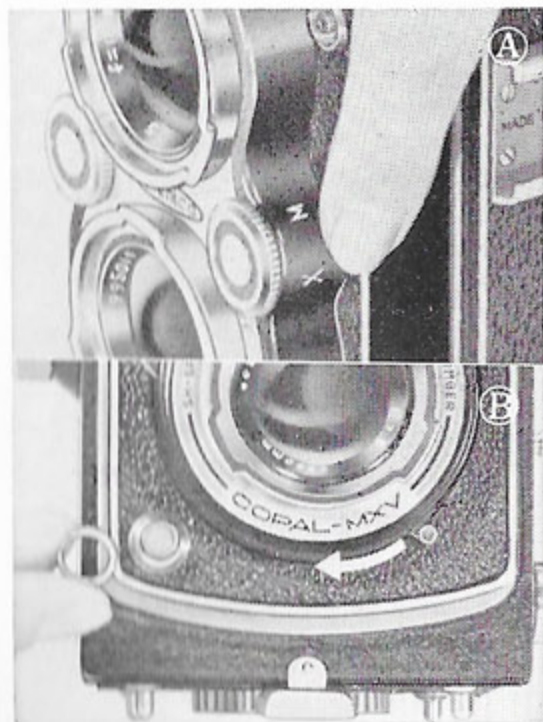

UNLOADING FILM

After taking all 12 pictures turn the Film Winding Knob about 6 turns, to take up the remaining film. Then open the camera and remove the film.

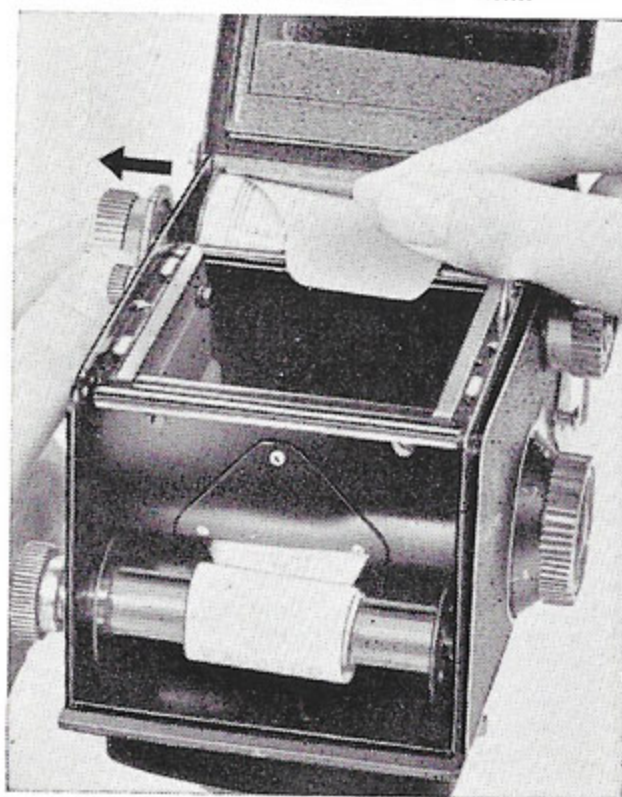

SIGHTING THE SUBJECT AND FOCUSING

You see the picture before taking

Your Yashica is a twin-lens reflex camera. The lower lens takes the picture. The upper lens is for focusing and composing on the ground glass viewing screen.

To begin, open the Focusing Hood by lifting it at the back. Now point your Yashica at the subject.

Rotate the Focusing Knob until your subject on the ground glass screen is sharp. At the same time compose your subject on the ground glass as you would like to see it in the final picture.

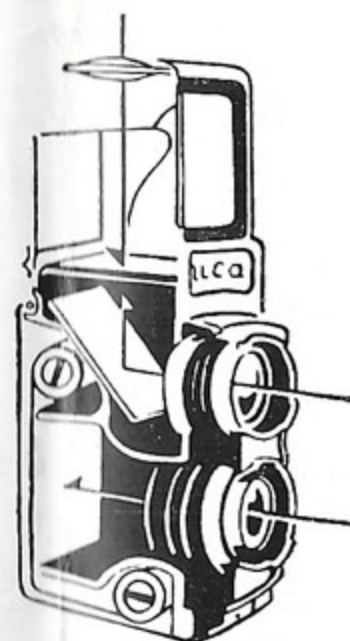

COMPOSING

Is unusually simple on the Yashica's ground glass viewing screen. The 2 red guide lines help you for properly composing your pictures.

In addition to focusing, there are two basic adjustments on any fine camera: the LENS APERTURE or OPENING and the SHUTTER SPEED.

THE LENS OPENING

The Lens Aperture controls the amount of light that will pass through the lens onto the light-sensitive film. Your Yashica-635, with its Yashikor lens, offers openings at f: 3.5 4 5.6 8 11 16 22.

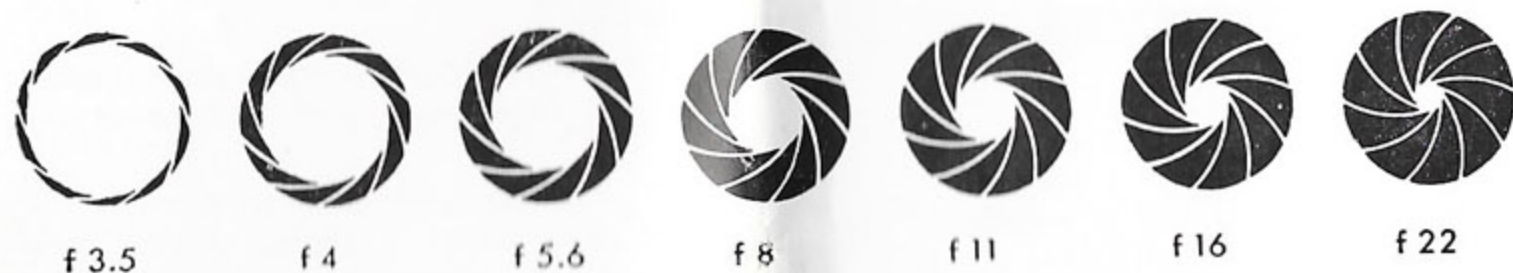

Notice that the lower the number, the larger the opening. F 3.5 is the largest opening, f: 22 the smallest.

To set the lens opening, move the Aperture Control Lever to the desired number on the Aperture Scale.

SHUTTER SPEED

The shutter Speed controls the duration of the exposure. Shutter speeds on your Yashica-635 with its fine Copal Shutter are 1, 1/2, 1/5, 1/10, 1/25, 1/50, 1/100, 1/250, 1/500 of a second and B. The 'B' setting is for taking pictures with an exposure longer than 1 second. Use a Tripod or Brace when using B. When you press the Shutter Release Button on the 'B' setting, the shutter stays open until you release pressure on the button.

It is advisable to set the shutter speed before you cock the shutter at all times.

Camera may be Hand Held				Use a Tripod or Brace			
Average Pictures			Action Pictures	Time Exposure	Slow speeds		
1/25	1/50	1/100	1/250 1/500	'B'	1 Sec	1/2	1/5 1/10

EXPOSURE

Exposure means finding the right combination of lens-opening (aperture) and shutter speed in relation to the sensitivity (ASA) of your film. (ASA indicates American Standard Association). For example, if you are using a film of ASA 200 (TRI-X type) sensitivity your correct exposure will be according to the following table:

DAYLIGHT EXPOSURE TABLE				
Your shutter speed will be 1/100 with aperture numbers shown below.				
	Bright Sun	Hazy Sun	Cloudy-Bright	Cloudy-Dull or Open Shade (4)
Light Subject (1)	f/32	f/22	f/16	f/11
Average Subjects (2)	f/22	f/16	f/11	f/8
Dark Subjects (3)	f/16	f/11	f/8	f/5.6

(1) Light Subjects: Distant landscapes, near-by people with sea, beach and snow scenes in the background.

(2) Average Subjects: Near-by people, houses, gardens, buildings and places not in the shade. Advisable to use this class when light and dark objects are in about equal proportions.

(3) Dark Subjects: People in dark clothing; trees, flowers, animals and large buildings.

(4) Open Shade: Subjects shaded from the sun but lighted by a wide area of open sky. The less the open sky the larger the lens opening.

If you are using an ASA 100 film, you will make a larger lens-opening or lower your shutter speed (1/50).

But if you never want to make a mistake, use an exposure meter. Be sure to consult your local camera dealer.



When fences or other obstructions are in your way you can hold your Yashica over head, focusing and viewing from below.



Steady the camera on your knee when taking pictures from a lower level.

HOLDING THE CAMERA



Hold the camera steady, then gently push the Shutter Release Button.



For low objects rest the Yashica on the ground.



Use the Sportsfinder for taking pictures eye level.

DEPTH-OF-FIELD

When you focus the camera on a subject there is a certain distance in front and back of the subject within which other objects will also appear sharp. This is known as the "Depth-of-Field", and it varies with the lens aperture. The smaller the aperture the greater the Depth-of-Field; it is much larger at $f:22$ than at $f:3.5$.

At the focusing knob is a scale which will indicate the Depth-of-Field when the camera is focused at various distances. You will notice that on either side of the $f:3.5$ figure is a similar set of numbers which represent lens apertures. When the camera is focused on your subject, look for the aperture you are using on either side of the scale to determine the Depth-of-Field. Thus, if the camera is focused at 10 feet and the lens aperture is $f:8$ the Depth-of-Field (area in which all objects are sharp) is from about 8 ft. to 13 ft.

You can also use the depth-of-field scale to use your Yashica as a fixed-focus camera. In this case set the infinity mark on the distance scale opposite the lens aperture being used. If the aperture is $f:8$ you will notice that all objects from about 25 feet to infinity will be sharp.

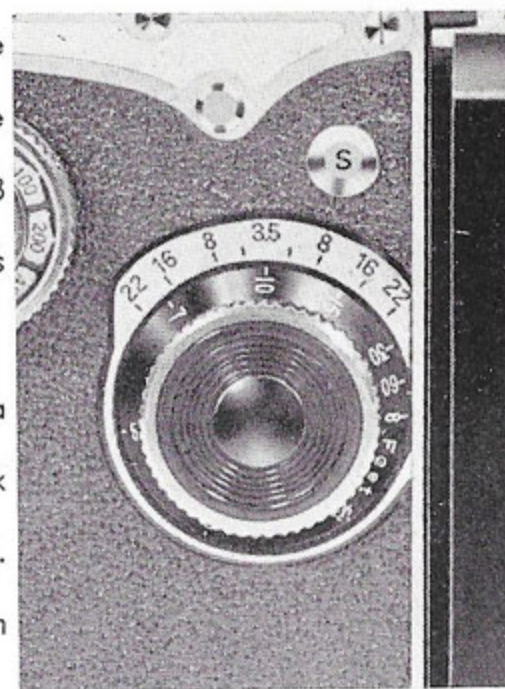

FILTERS

Your Yashica-635 accepts sunshades and filters' adapter rings in convenient Bayonet mounts that readily fasten to the 'taking' lens. A complete range of filters and supplementary lenses are available in the popular Series V size Bay ϕ 30.

Initially, you will find a yellow filter ideal for bringing out clouds in landscape pictures and for general uses. As you become more advanced, you may want to use various filters such as orange, green, etc. for different effects. Your camera dealer will give you complete information.

Notice !

Be sure to replace the Lens Cap when your camera is not in use. Keep your camera away from dust and moisture. For cleaning the lens surface to remove dust or dirt, always wipe very lightly by using clean gauze or lens cleaning cloth. Do not wipe the lens with a dirty handkerchief. When you are not using your camera for a long period do not leave the shutter set. In such cases place the Lens Cap over the lens to avoid exposure, and release the shutter.

REVIEW :

- a Select your exposure combination
- b Set the lens opening (aperture)
- c Set the shutter speed
- d 'Cock' the shutter
- e Focus on the ground glass screen
- f Compose (on the ground glass or through the sportsfinder)
- g Take the picture
- h Advance the film



Yashica

YASHIMA OPTICAL IND. CO., LTD.

Printed in Japan